

PASSENGER TRANSPORT WINDOW

SACRIFICIAL ANTI-GRAFFITI POLYESTER FILM

APPLICATION TECHNIQUES

Polyester film (PF)

Contents:

- Tools and Consumables
- Removing old PF
- Cleaning the glass
- Removing the release liner
- PF application
- Using the trim guide and knife
- Drying off PF peripheral edge
- Cold weather application
- Final inspection

IMPORTANT

- Please refer to document 'A Review of Issues Relating to the use of Sacrificial Anti-Graffiti Films 2001'
- Polyester film will not fill in scratches on glass, although the adhesive may slightly 'level out' smaller abrasions
- It is not recommended to apply polyester film to any glass that curves in two planes
- Most transport films are between 100-175 microns thick and therefore are easily creased if not careful
- Filming must be carried out in dust free, draught free environments with temperatures above 5°C
- The cleaning preparation is paramount to ensure installation performance
- Haziness may occur prior to full drying out, usually 2-4 weeks
- Clean polyester filmed glass with soft leather or soft cloth and warm water
- PSV Glass will not be liable for any damage, injury or loss, direct or consequential, arising from the application of polyester film

TOOLS and CONSUMABLES

Tools:

Part No.

■ **Polyester Film Application kit comprising of:**

12549

1. Cleaning squeegee (rubber)
2. Applicator squeegee large (nylon)
3. Applicator squeegee small (nylon)
4. Bartlett trimming knife
5. Razor edged scraper
6. Trim guide
7. 2 x Misting dispensers

Consumables:

- | | |
|--|-------|
| ■ Pre-cut polyester film from cassette | |
| ■ Adhesive removal solvent 2.5l | 12547 |
| ■ Preparation solution 2.5l | 12545 |
| ■ Application slip concentrate 250ml | 12546 |
| ■ Bartlett trimming knife blades | 12544 |
| ■ PSV Glass 'Lo-Tac' masking tape | 12551 |
| ■ 12548-paper towels | 12548 |

REMOVING OLD POLYESTER FILM

Because the adhesive used in PF bonds very strongly to glass, removing old PF can be difficult. Instead of trying to remove the PF in one piece on large windows, cut the PF vertically in strips of 30cm to 40cm wide, and then with constant pressure pull PF off slowly. (Use only stainless steel blades).

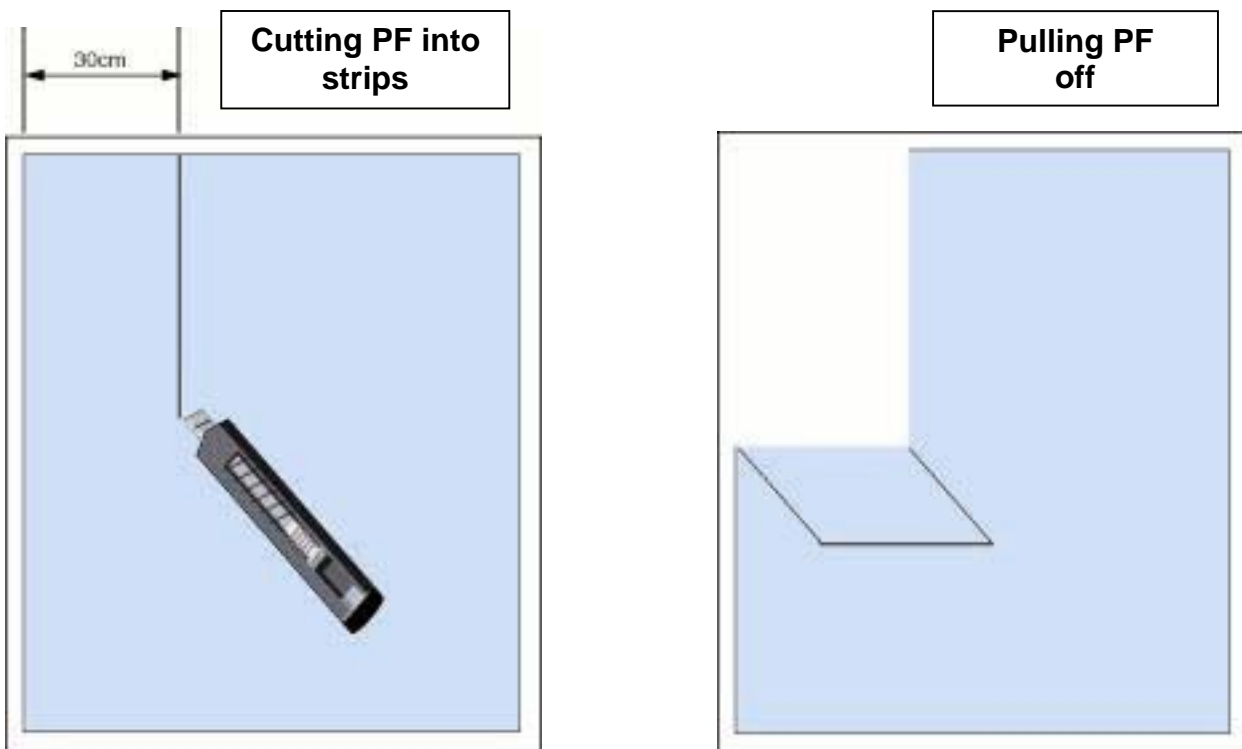

Low grade PF's may leave a sticky residual layer of adhesive behind that has been baked on to the glass by UV light. This must be thoroughly removed, using adhesive removal solvent, before even attempting to clean / prepare the glass.

CLEANING THE GLASS

Windows must be cleaned just prior to installing new PF. It is very important to clean both the glass and the frame thoroughly. This is done using the preparation solution, razor edge scraper, cleaning squeegee and 12548-paper towels.

To clean windows thoroughly, follow the three- step procedure below:

1. Spray the glass thoroughly with preparation solution and scrape with the razor edged scraper. Use the blade across the entire surface of the glass. Scrape horizontally and vertically rather than diagonally across the glass.
2. Re-spray the window and wipe both the glass and the window frame with 12548-paper towel. This will pick up debris loosened by the scraper. Be sure to wipe any grime off the surrounding frame. Remove all grime from the edges and be sure that they are completely clean.
3. Re-spray the window and use the window-cleaning squeegee to dry the glass. Squeegee in a horizontal direction only, starting at the top of the glass and working downward. Use 12548-paper towel to wipe the blade after each stroke. Also use 12548-paper towel to wipe the edges of the glass and frame.

Proper use of a squeegee is important for getting a window completely clean. First the rubber blade must be in good condition. After spraying the glass with preparation solution, wipe it dry with horizontal strokes. Pull the squeegee from side to side in single strokes all the way across the glass.

NEVER use cloths or rags to clean the glass, they leave lint that is difficult to remove and will end up behind the film.

REMOVING THE RELEASE LINER

First, check you have selected the correct pre-cut PF from the cassette box.

Mix the application slip solution concentrate with de-mineralised water, as per instructions.

The release liner protects the PF adhesive surface.

To remove the release liner, carefully lift up one corner and begin to separate the release liner. Start to peel back, whilst liberally spraying with the application slip solution. At the same time, spray the glass with the application slip solution. Once the release liner has been loosened, peel it completely off.

Spray the adhesive surface and glass again with the application slip solution prior to floating the ready PF onto the glass.

It would normally take two installers for this operation.

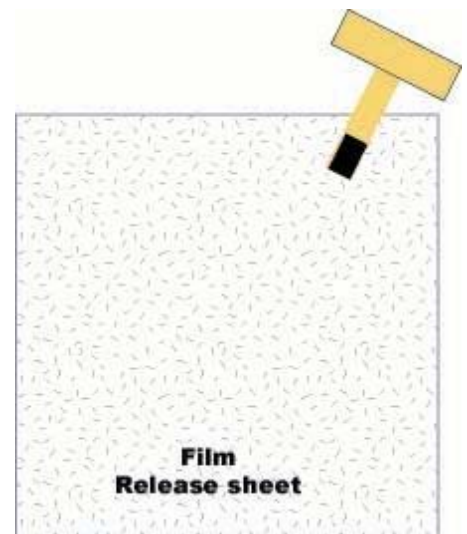

Once the adhesive layer is exposed, care must be taken to keep it free from dirt, and lint.

Single installer operation:

Small sheets can be readily prepared for hanging by a single installer holding the PF in his hands. Pull the release liner away and wet the adhesive. Alternatively, tape tabs can be used.

Tape tabs are used to hang PF from walls or windows while removing the release liner and spraying. As shown in the illustration, the tabs are made from two-inch masking tape. Corners of the PF are stuck onto outward facing pieces of tape. Those outward facing pieces have folded ends so that they can easily be removed from the PF.

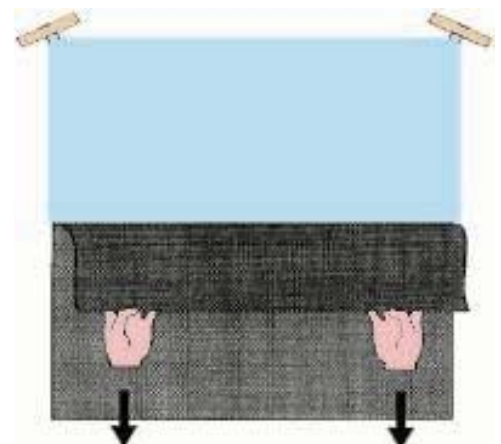

PF APPLICATION

Thoroughly wet the glass and adhesive with the application slip solution.

After removing the release liner from the PF, touch it to the glass at a single point near the top.

Float the PF onto the glass ensuring no contact is made with the frame margin. Centralise the PF with the window aiming to achieve an even peripheral gap. Adjust position of PF to remove large folds and bubbles.

Spray the surface of the PF thoroughly with the application slip solution. The application slip solution is then removed from behind the PF by pushing it with a squeegee toward the edges. The illustration below shows the correct sequence of strokes.

Always use a high squeegee angle to avoid marking the PF.

First squeegee: Figs 1 and 2 below show the correct sequence of strokes. Initial horizontal strokes at the top of the film anchor it in place.

Subsequent strokes are all downward, working from the top to the bottom of the window, never overlapping more than 10 cm with each stroke.

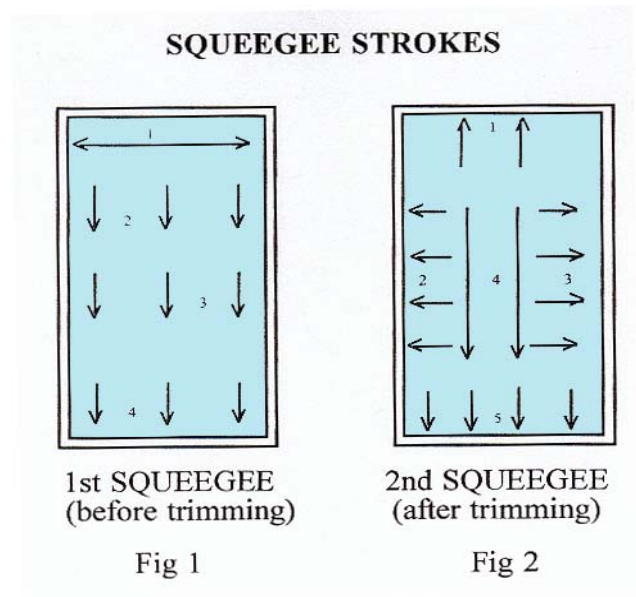

For both practical and aesthetic reasons, if using PF direct from a roll, it is very important not to allow the PF to overlap onto the rubber gasket or frame: If this occurs follow procedures on following page Fig. 3 before proceeding to second squeegeeing step.

Second squeegee: re-wet surface of PF and follow sequence in Fig. 2

USING THE TRIM GUIDE AND KNIFE

A 1.5mm gap between the edge of the PF and the frame margin on the border of the window is created by cutting along the inside length of the trim guide. It is placed flush against the frame margin and the sharp blade of the Bartlett knife cuts away the extra film.

It is possible to hood the blade and guide in a way that allows a single, long cut along a side of a window. Hold the blade against the trim guide and the guide along the edge, keeping it firmly against the frame. This will result in a quick, smooth cut.

Trimming small panes: On passenger doors and smaller pieces of glass, a normal size gap (1.5mm) often looks too large. Make these even thinner by using the window frame as a guide rather than a trim guide.

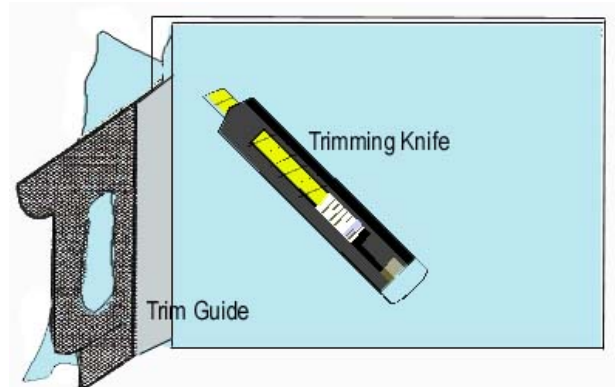

DRYING OFF PF PERIPHERAL EDGE

After the PF has been positioned, trimmed, and squeegeed, use a 12180-paper towel to dry edges and corners (but not the main surface of the PF). Fold a few squares of 12180 paper towel over the edge of the trim guide and use it to blot the moisture from the edges of the PF to make sure correct adhesion has taken place. Start 5 – 7cm away from the frame and press the towel-covered guide against the glass to remove excess application slip solution.

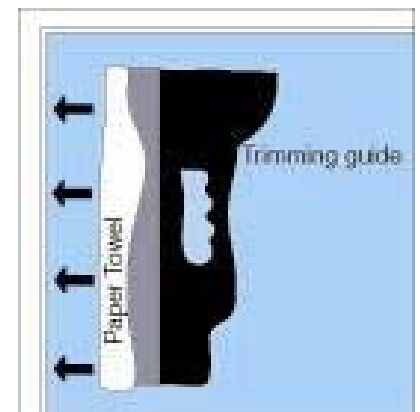

Because application slip solution will seep from under the PF to the edges and corners, toweling may be necessary several times before the edges are adhered correctly.

Be aware that the capillary action of the spent application slip solution may drag back debris from under the frame margin and deposit under the new PF.

COLD WEATHER APPLICATION

During cold weather, you must be more careful to avoid a problem called “apexing.” This results when moisture builds up underneath the PF due to condensation on the glass

If the PF is not squeegeed uniformly down the length of the window, some cross tension will exist. When condensation occurs, this tension pulls the PF and can result in it pulling loose wherever the bond is weakest; the PF then forms a small ridge called an apex. If allowed to dry, it will ruin the installation.

To avoid apexing, be sure to neutralize the tension in the PF by squeegeeing the entire window vertically using strokes of not more than 20cm. This will allow the PF to bond to the glass naturally and without surface tension.

FINAL INSPECTION

Application slip solution has a water additive that when used as directed with demineralised water will act as a slipping agent during installation. This solution has been found to produce an optically clear result. Using application slip solutions other than the recommended 12546 may result in a sub-standard appearance, due to residual matter being left between the PF and glass surface.

Correct application techniques are essential in removing application slip solution from between PF and the glass. When squeegeeing is required, it is recommended to push the solution out from under the PF rather than to pull it, as is commonly done in cleaning windows. Always wet the surface of the PF before squeegeeing as moisture acts as a lubricant to the PF surface.

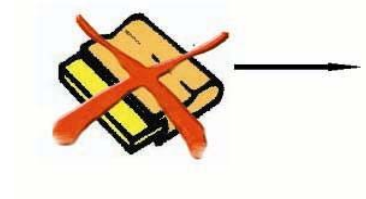
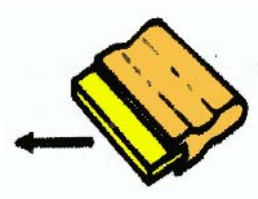

Special note... The haze level or milkiness of the silicone release liner may be different from batch to batch. This should not be construed as a problem, but rather a difference in the base PF utilized in the release liner.